

DE5S4M

40V 5A

FEATURES

- SMT
- $T_j 150^{\circ}\text{C}$
- P_{RRSM} avalanche guaranteed
- High current capacity with Small Package

APPLICATION

- Switching power supply
- DC/DC converter
- Home Appliances, Office Equipment
- Telecommunication

OUTLINE DIMENSIONS

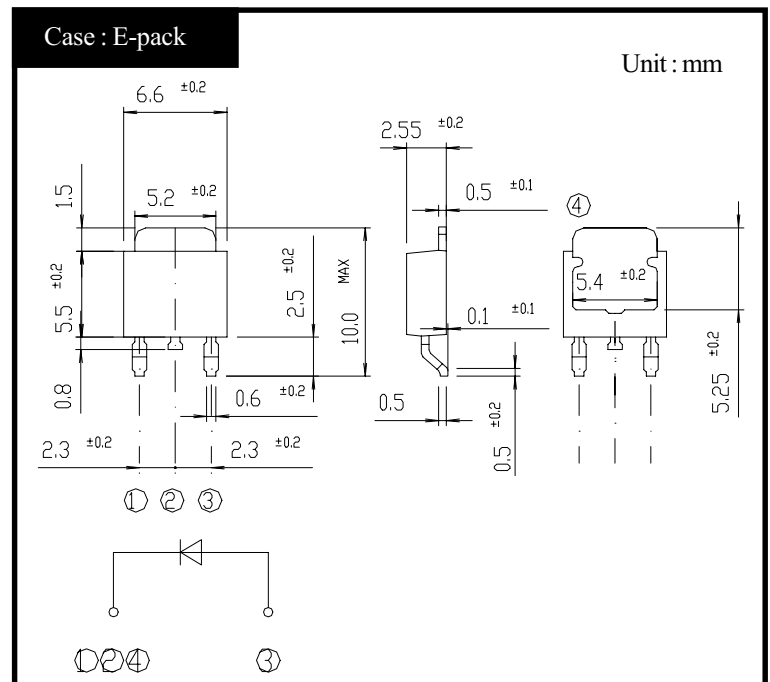

RATINGS

● Absolute Maximum Ratings (If not specified $T_c=25^{\circ}\text{C}$)

Item	Symbol	Conditions	Ratings	Unit
Storage Temperature	T_{stg}		-40~150	$^{\circ}\text{C}$
Operating Junction Temperature	T_j		150	$^{\circ}\text{C}$
Maximum Reverse Voltage	V_{RM}		40	V
Repetitive Peak Surge Reverse Voltage	V_{RRSM}	Pulse width 0.5ms, duty 1/40	45	V
Average Rectified Forward Current	I_o	50Hz sine wave, R-load With heatsink $T_c=101^{\circ}\text{C}$	5.0	A
		50Hz sine wave, R-load Without heatsink $T_a=25^{\circ}\text{C}$	3.1	
Peak Surge Forward Current	I_{FSM}	50Hz sine wave, Non-repetitive 1 cycle peak value, $T_j=125^{\circ}\text{C}$	80	A
Repetitive Peak Surge Reverse Power	P_{RRSM}	Pulse width 10 μs , $T_j=25^{\circ}\text{C}$	330	W

● Electrical Characteristics (If not specified $T_c=25^{\circ}\text{C}$)

Item	Symbol	Conditions	Ratings	Unit
Forward Voltage	V_F	$I_F=5\text{A}$, Pulse measurement	Max.0.55	V
Reverse Current	I_R	$V_R=V_{RM}$, Pulse measurement	Max.3.5	mA
Junction Capacitance	C_j	$f=1\text{MHz}$, $V_R=10\text{V}$	Typ.180	pF
Thermal Resistance	θ_{jc}	junction to case	Max.12	$^{\circ}\text{C}/\text{W}$
	θ_{ja}	junction to ambient	Max.55	

DE5S4M

Forward Voltage

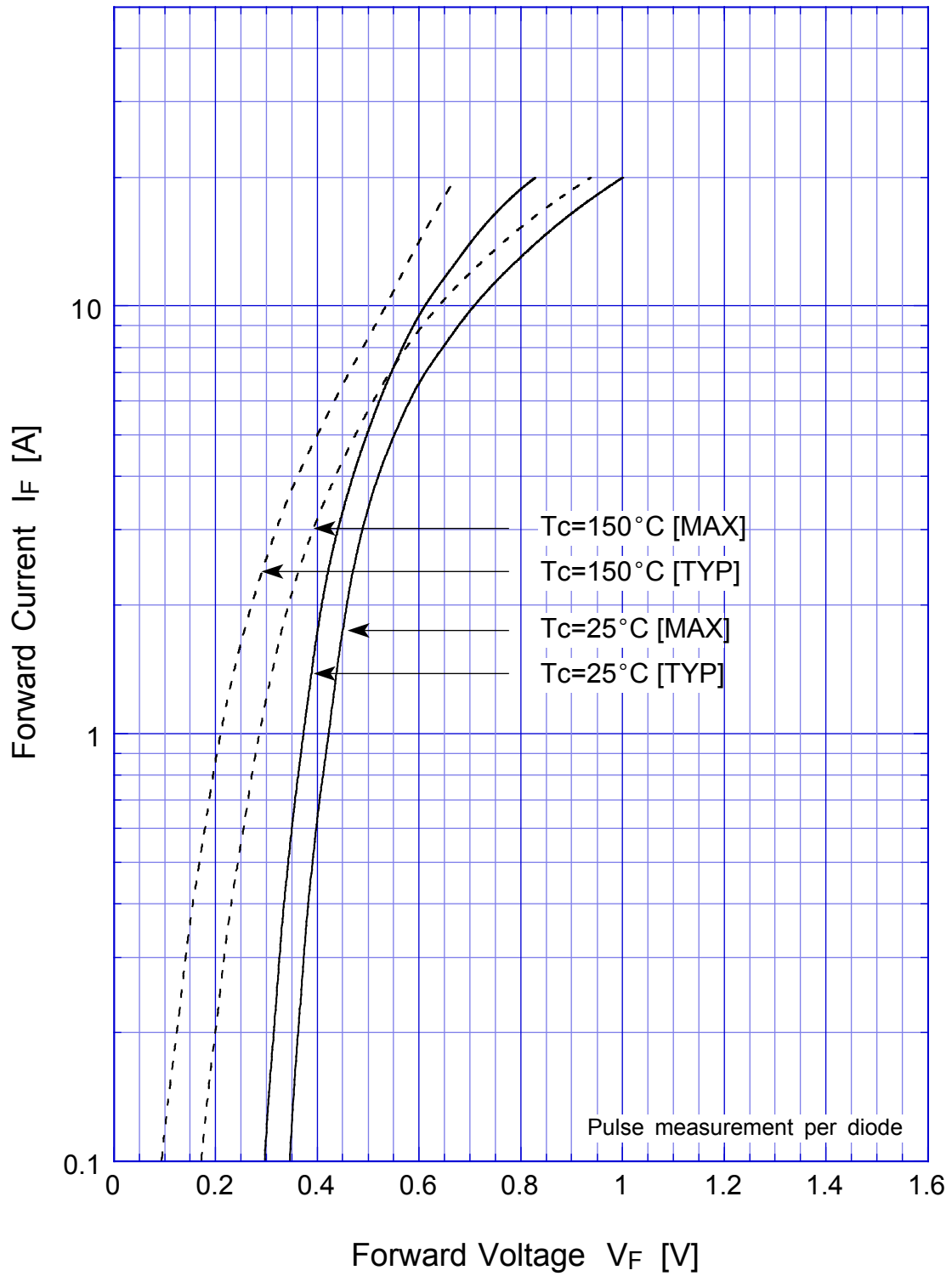

DE5S4M

Junction Capacitance

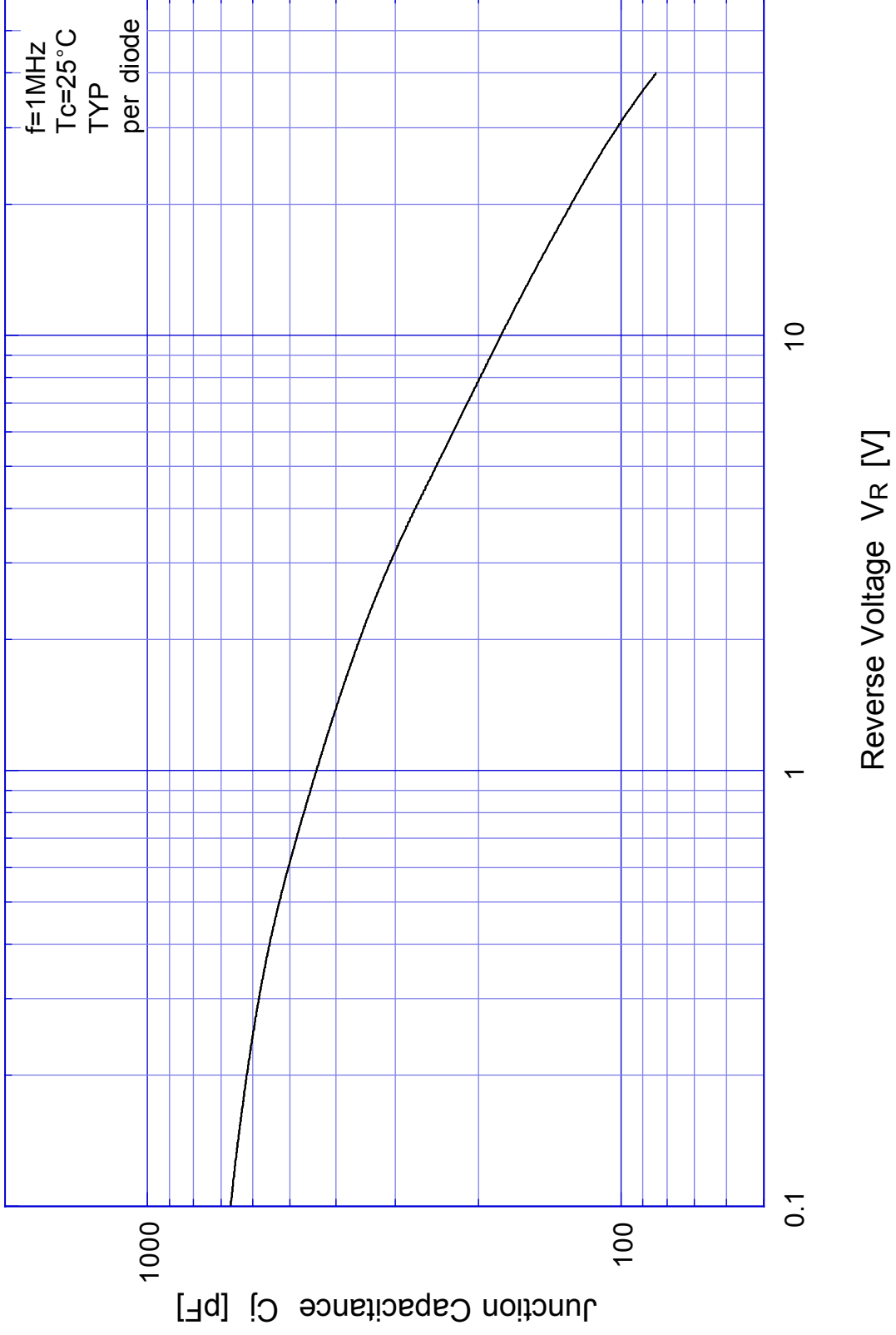

DE5S4M

Reverse Current

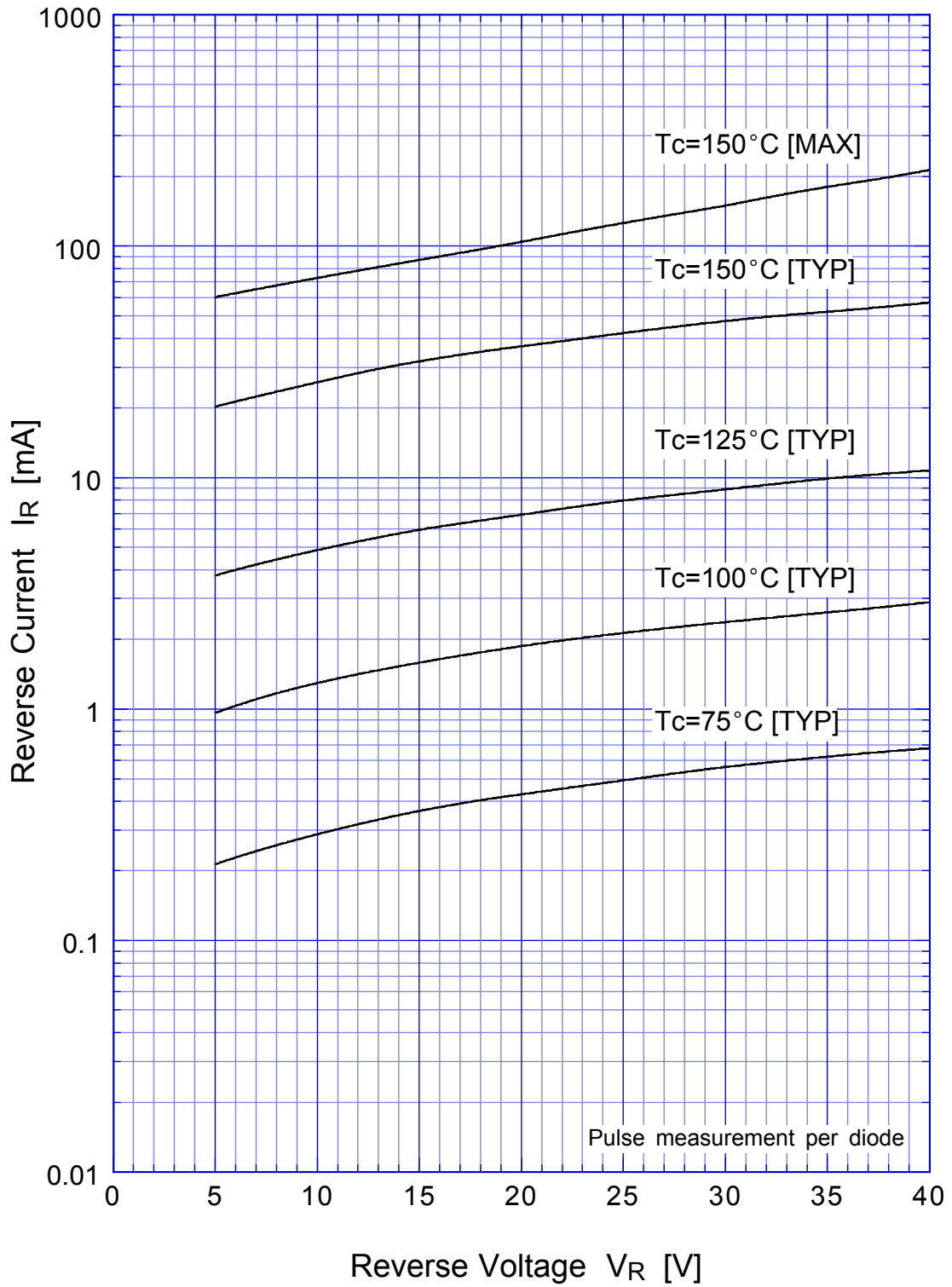

DE5S4M Reverse Power Dissipation

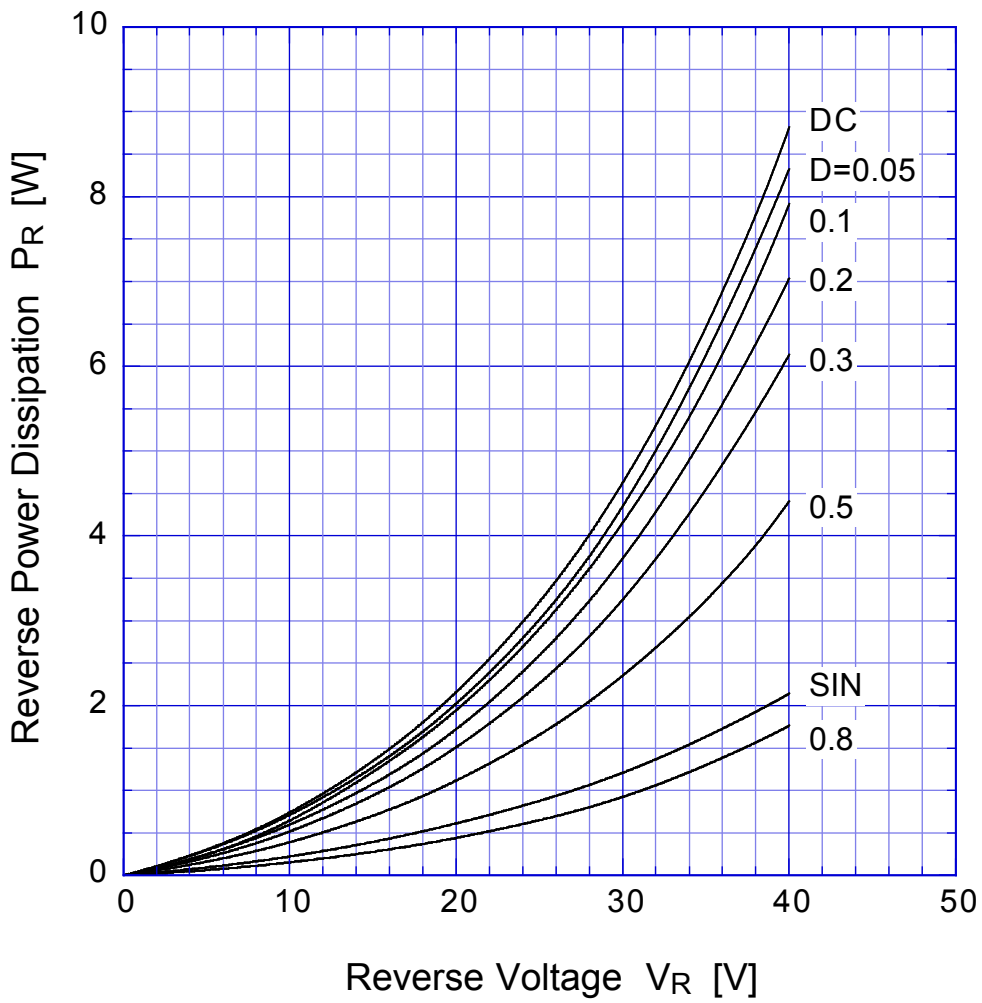

$T_j = 150^\circ\text{C}$

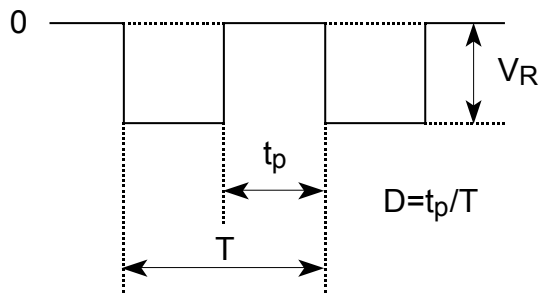

DE5S4M Forward Power Dissipation

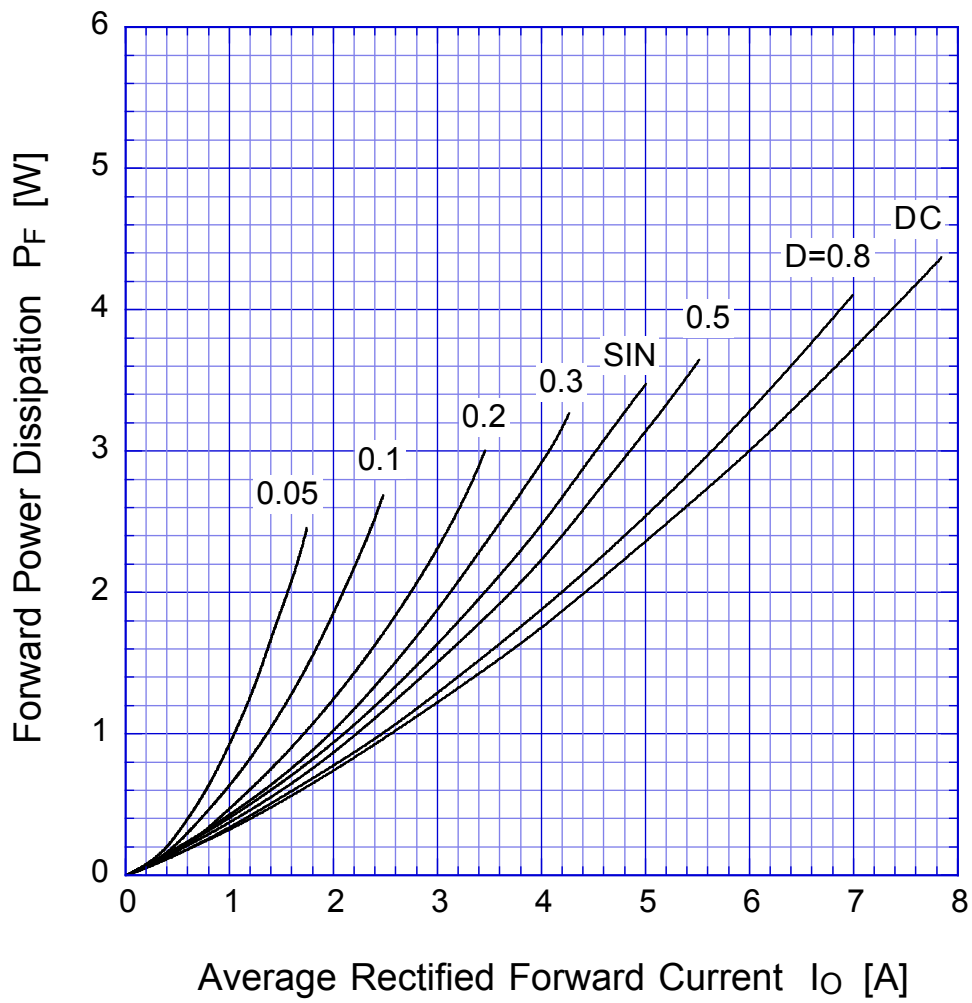

$T_j = 150^\circ\text{C}$

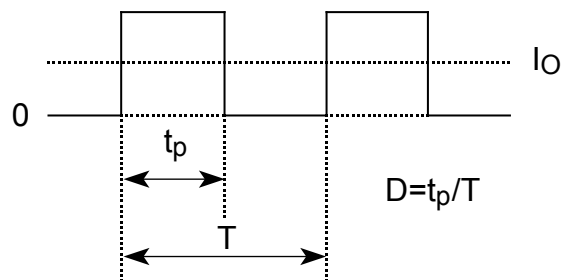

DE5S4M

Derating Curve

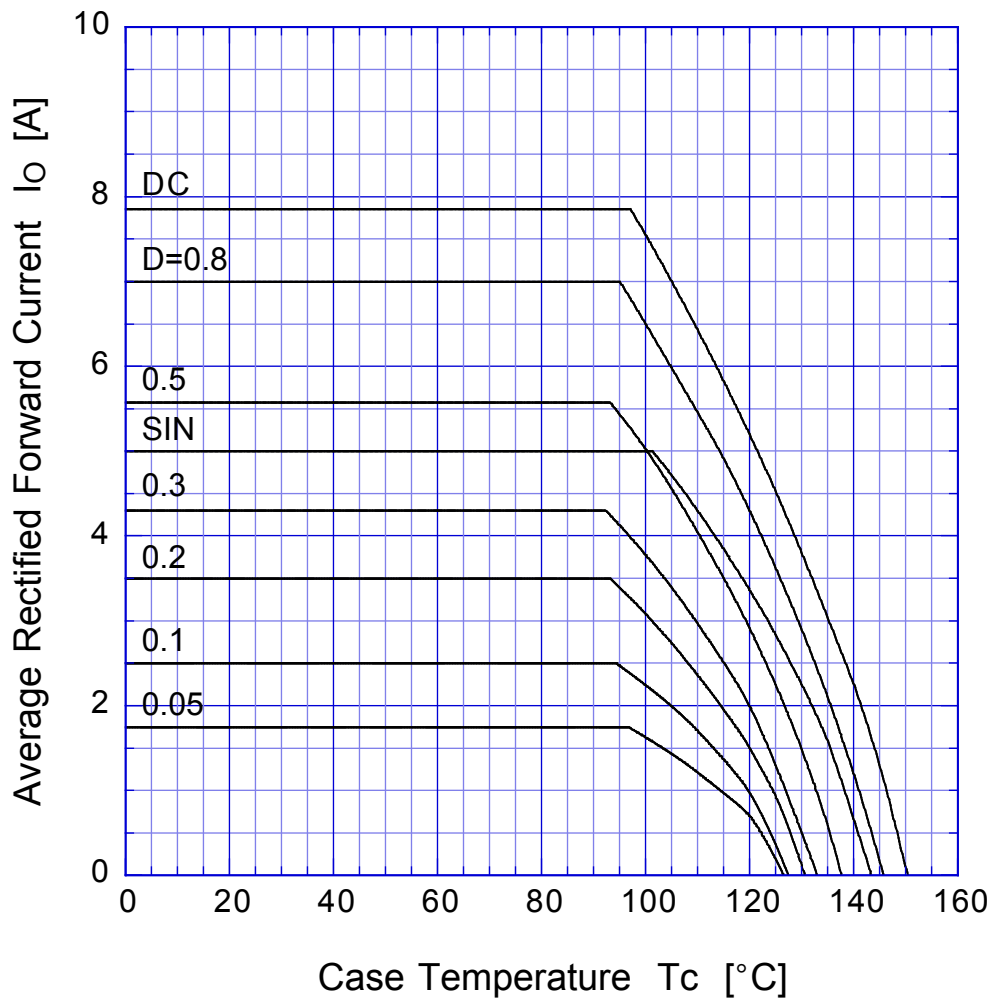

$V_R = 20V$



DE5S4M

Derating Curve

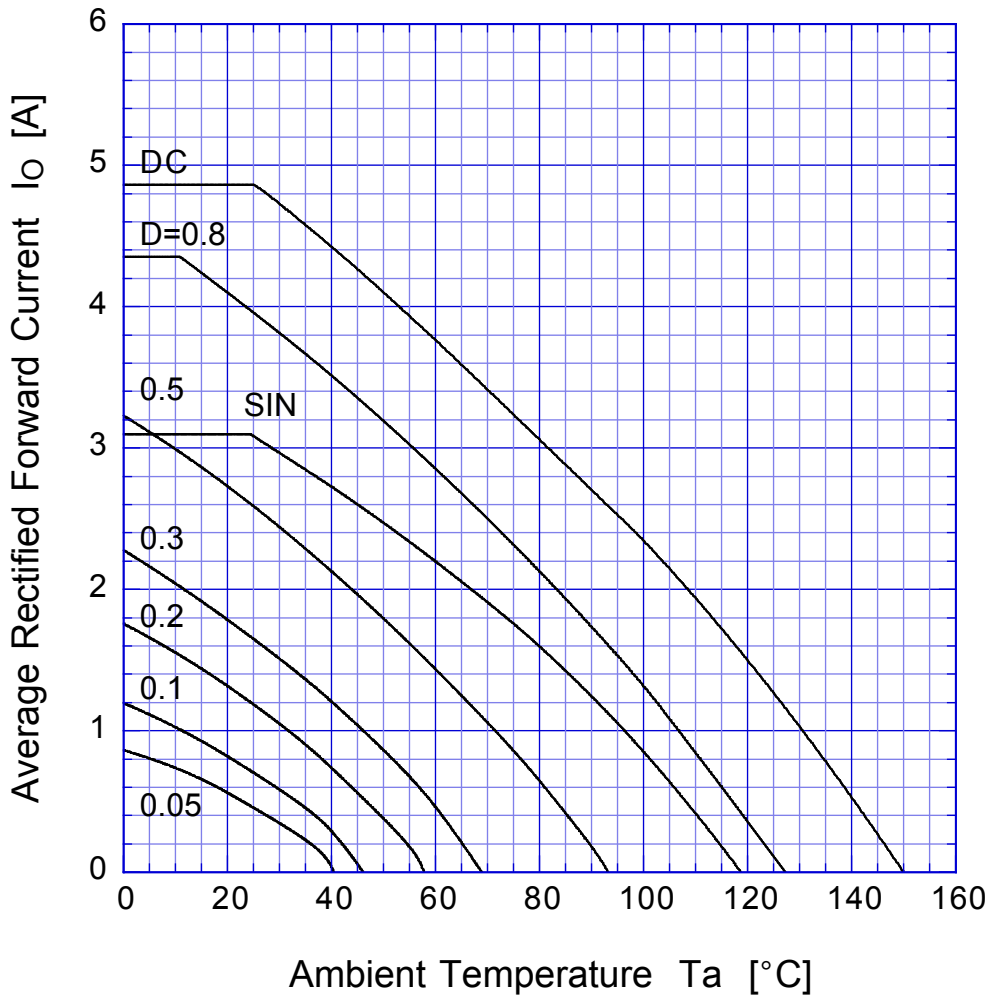

$V_R = 20V$

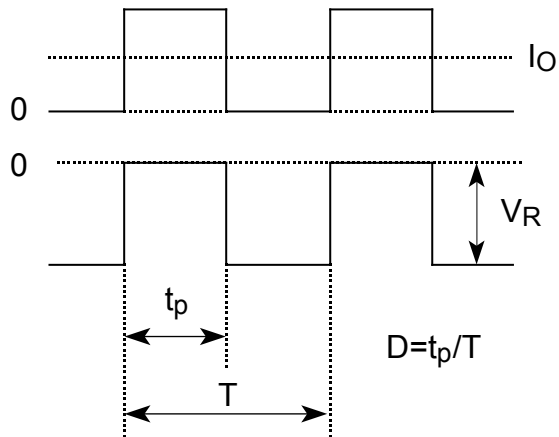

DE5S4M

Derating Curve

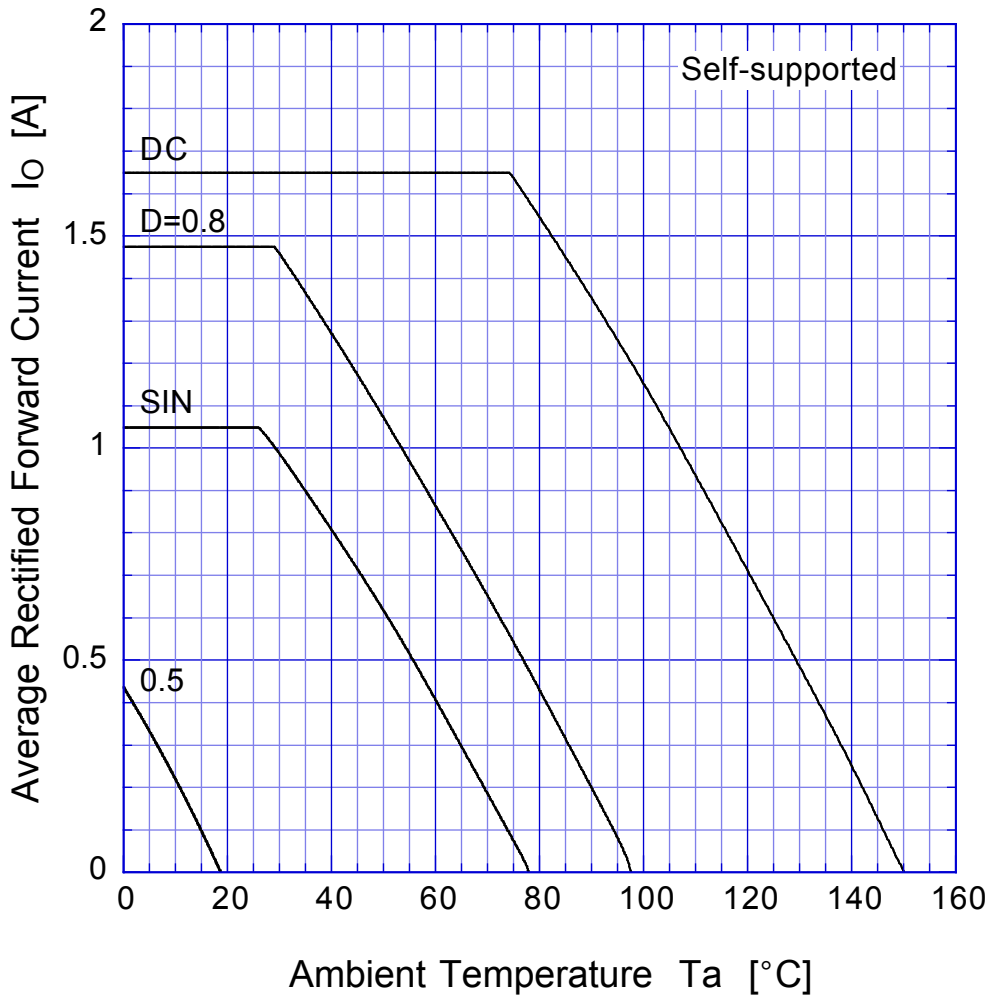

$V_R = 20V$

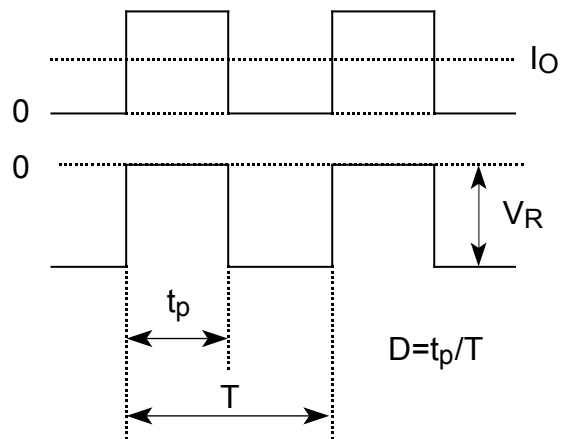

DE5S4M

Peak Surge Forward Capability

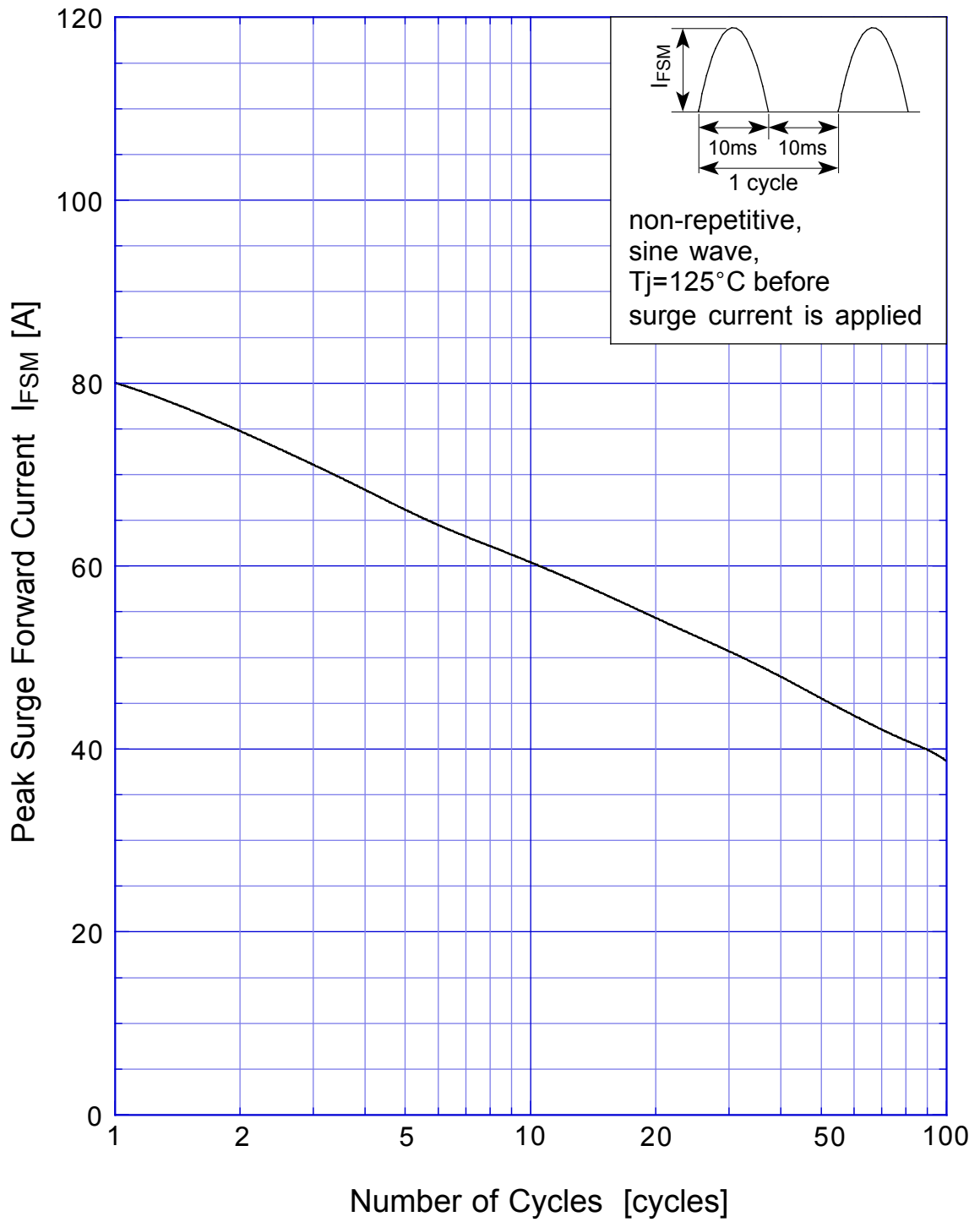

SBD Repetitive Surge Reverse Power Derating Curve

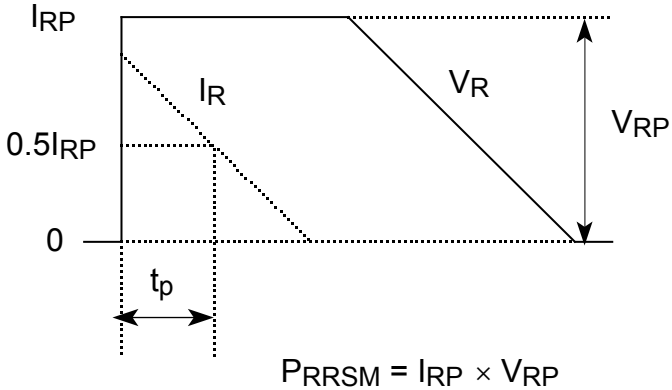
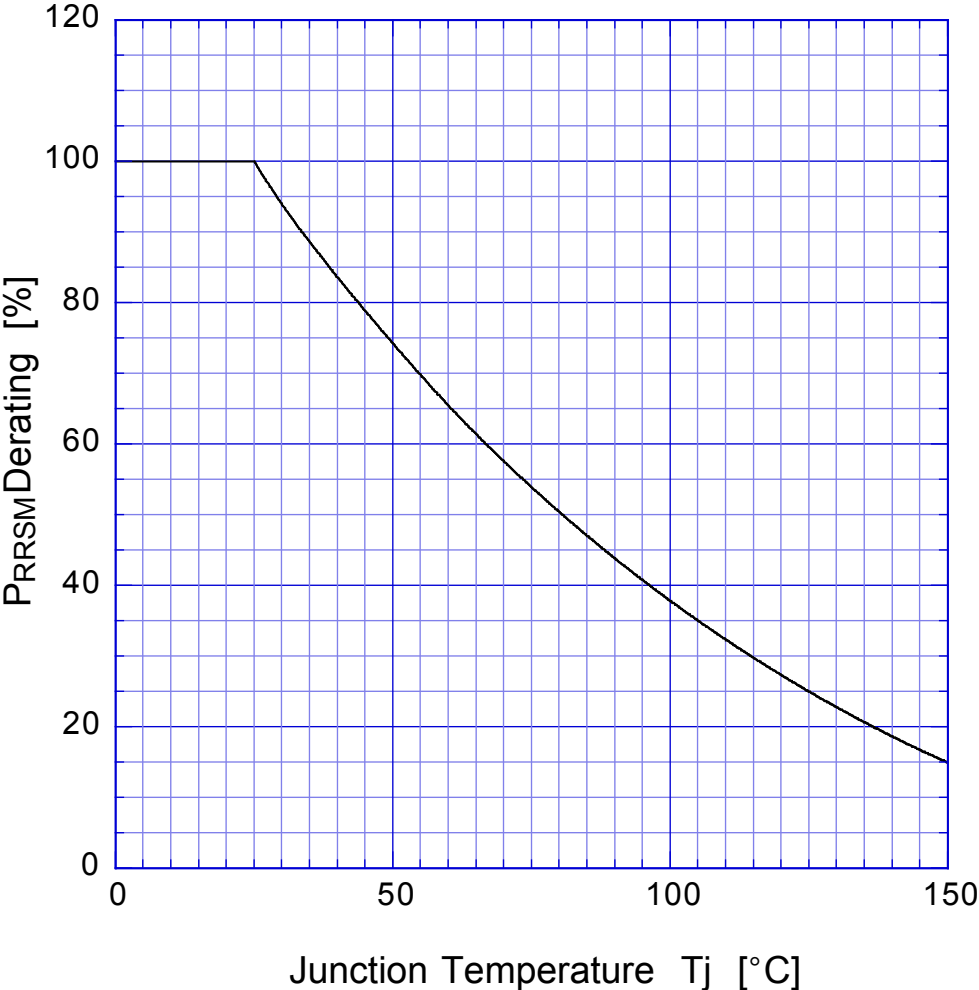

SBD

Repetitive Surge Reverse Power Capability

