

TOSHIBA Photocoupler GaAs IRed & Photo-Transistor

TLP631, TLP632

Programmable Controllers
 AC / DC-Input Module
 Solid State Relay

The TOSHIBA TLP631 and TLP632 consist of a photo-transistor optically coupled to a gallium arsenide infrared emitting diode in a six lead plastic DIP.

TLP632 is no-base internal connection for high-EMI environments.

- Collector-emitter voltage: 55 V (min.)
- Current transfer ratio: 50% (min.)
 Rank GB: 100% (min.)
- Isolation voltage: 5000V_{rms} (min.)
- UL recognized: UL1577, file no. E67349

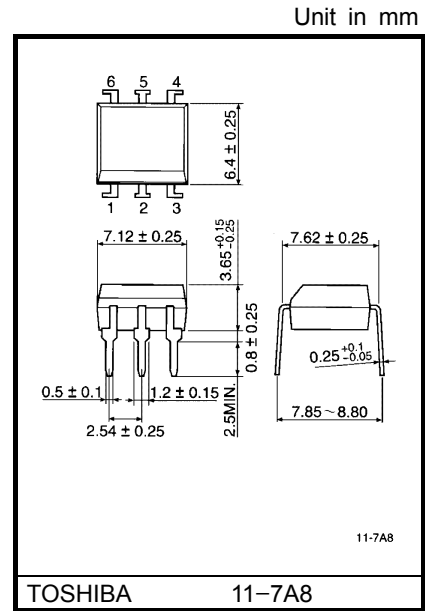

Weight: 0.4 g

Pin Configurations (top view)

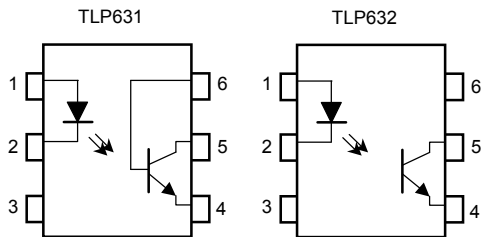

1: Anode
 2: Cathode
 3: N.C.
 4: Emitter
 5: Collector
 6: Base

1: Anode
 2: Cathode
 3: N.C.
 4: Emitter
 5: Collector
 6: N.C.

Absolute Maximum Ratings (Ta = 25°C)

Characteristic		Symbol	Rating	Unit
LED	Forward current	I _F	60	mA
	Forward current derating (Ta ≥ 39°C)	ΔI _F / °C	-0.7	mA / °C
	Peak forward current (100μs pulse, 100pps)	I _{FP}	1	A
	Reverse voltage	V _R	5	V
	Junction temperature	T _j	125	°C
Detector	Collector-emitter voltage	V _{CEO}	55	V
	Collector-base voltage (TLP631)	V _{CBO}	80	V
	Emitter-collector voltage	V _{ECO}	7	V
	Emitter-base voltage (TLP631)	V _{EBO}	7	V
	Collector current	I _C	50	mA
	Power dissipation	P _C	150	mW
	Power dissipation derating (Ta ≥ 25°C)	ΔP _C / °C	-1.5	mW / °C
	Junction temperature	T _j	125	°C
Storage temperature range		T _{stg}	-55~125	°C
Operating temperature range		T _{opr}	-55~100	°C
Lead soldering temperature (10s)		T _{sol}	260	°C
Total package power dissipation		P _T	250	mW
Total package power dissipation derating (Ta ≥ 25°C)		ΔP _T / °C	-2.5	mW / °C
Isolation voltage (AC, 1 min., R.H. ≤ 60%)		BV _S	5000	V _{rms}

Note: Using continuously under heavy loads (e.g. the application of high temperature/current/voltage and the significant change in temperature, etc.) may cause this product to decrease in the reliability significantly even if the operating conditions (i.e. operating temperature/current/voltage, etc.) are within the absolute maximum ratings.

Please design the appropriate reliability upon reviewing the Toshiba Semiconductor Reliability Handbook ("Handling Precautions"/"Derating Concept and Methods") and individual reliability data (i.e. reliability test report and estimated failure rate, etc).

Recommended Operating Conditions

Characteristic	Symbol	Min.	Typ.	Max.	Unit
Supply voltage	V _{CC}	—	5	24	V
Forward current	I _F	—	16	25	mA
Collector current	I _C	—	1	10	mA
Operating temperature	T _{opr}	-25	—	85	°C

Note: Recommended operating conditions are given as a design guideline to obtain expected performance of the device. Additionally, each item is an independent guideline respectively. In developing designs using this product, please confirm specified characteristics shown in this document.

Individual Electrical Characteristics (Ta = 25°C)

Characteristic		Symbol	Test Condition	Min.	Typ.	Max.	Unit
LED	Forward voltage	V_F	$I_F = 10 \text{ mA}$	1.0	1.15	1.3	V
	Reverse current	I_R	$V_R = 5 \text{ V}$	—	—	10	μA
	Capacitance	C_T	$V = 0, f = 1 \text{ MHz}$	—	30	—	pF
Detector	Collector–emitter breakdown voltage	$V_{(BR) CEO}$	$I_C = 0.5 \text{ mA}$	55	—	—	V
	Emitter–collector breakdown voltage	$V_{(BR) ECO}$	$I_E = 0.1 \text{ mA}$	7	—	—	V
	Collector–base breakdown voltage (TLP631)	$V_{(BR) CBO}$	$I_C = 0.1 \text{ mA}$	80	—	—	V
	Emitter–base breakdown voltage (TLP631)	$V_{(BR) EBO}$	$I_E = 0.1 \text{ mA}$	7	—	—	V
	Collector dark current	I_{CEO}	$V_{CE} = 24 \text{ V}$	—	10	100	nA
			$V_{CE} = 24 \text{ V}, T_a = 85^\circ\text{C}$	—	2	50	μA
Capacitance collector to emitter	C_{CE}	$V = 0, f = 1 \text{ MHz}$	—	10	—	pF	

Coupled Electrical Characteristics (Ta = 25°C)

Characteristic	Symbol	Test Condition	Min.	Typ.	Max.	Unit
Current transfer ratio	I_C / I_F	$I_F = 5 \text{ mA}, V_{CE} = 5 \text{ V}$ Rank GB	50	—	600	%
			100	—	600	
Saturated CTR	$I_C / I_F (\text{sat})$	$I_F = 1 \text{ mA}, V_{CE} = 0.4 \text{ V}$ Rank GB	—	60	—	%
			30	—	—	
Collector–emitter saturation voltage	$V_{CE} (\text{sat})$	$I_C = 2.4 \text{ mA}, I_F = 8 \text{ mA}$	—	—	0.4	V

Isolation Characteristics (Ta = 25°C)

Characteristic	Symbol	Test Condition	Min.	Typ.	Max.	Unit
Capacitance (input to output)	C_S	$V_S = 0, f = 1 \text{ MHz}$	—	0.8	—	pF
Isolation resistance	R_S	$V_S = 500 \text{ V}, \text{R.H.} \leq 60\%$	5×10^{10}	10^{14}	—	Ω
Isolation voltage	BV_S	AC, 1 minute	5000	—	—	V_{rms}
		AC, 1 second, in oil	—	10000	—	
		DC, 1 minute, in oil	—	10000	—	V_{dc}

Switching Characteristics (Ta = 25°C)

Characteristic	Symbol	Test Condition	Min.	Typ.	Max.	Unit
Rise time	t_r	$V_{CC} = 10 \text{ V}, I_C = 2 \text{ mA}$ $R_L = 100 \Omega$	—	2	—	μs
Fall time	t_f		—	3	—	
Turn-on time	t_{on}		—	3	—	
Turn-off time	t_{off}		—	3	—	
Turn-on time	t_{ON}	$R_L = 1.9 \text{ k}\Omega$ (Fig.1) $R_{BE} = \text{OPEN}$ $V_{CC} = 5 \text{ V}, I_F = 16 \text{ mA}$	—	2	—	μs
Storage time	t_s		—	15	—	
Turn-off time	t_{OFF}		—	25	—	
Turn-on time	t_{ON}	$R_L = 1.9 \text{ k}\Omega$ (Fig.1) $R_{BE} = 220 \text{ k}\Omega$ (TLP631) $V_{CC} = 5 \text{ V}, I_F = 16 \text{ mA}$	—	2	—	μs
Storage time	t_s		—	12	—	
Turn-off time	t_{OFF}		—	20	—	

Fig. 1 Switching time test circuit

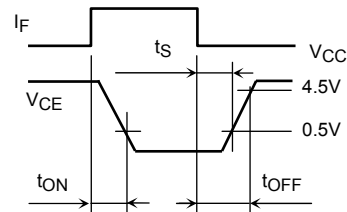
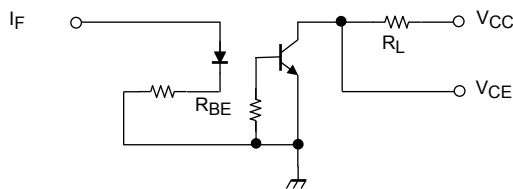

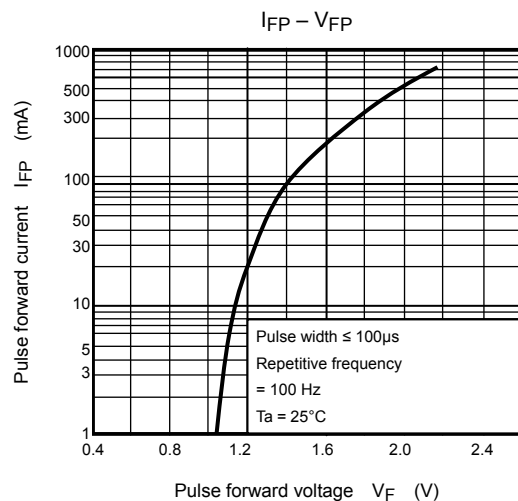
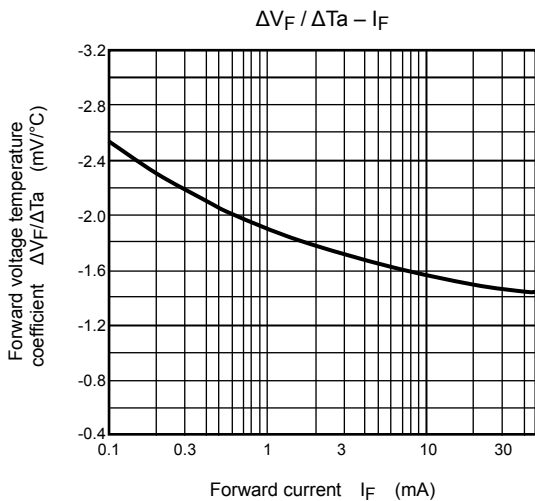
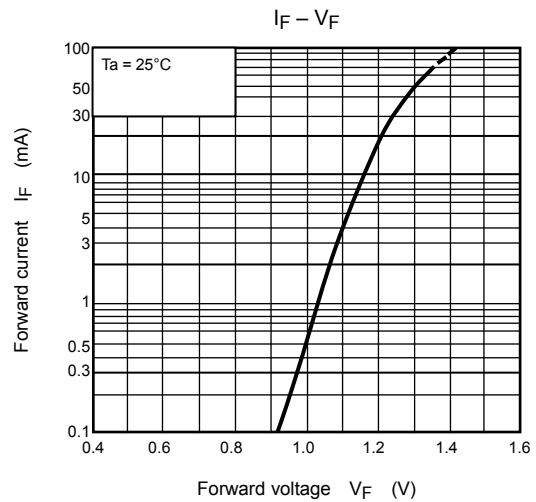
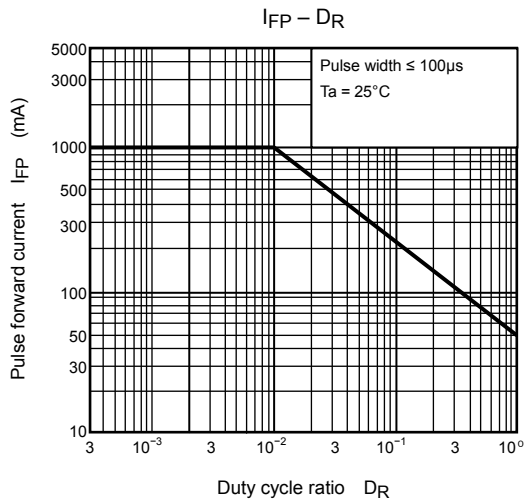
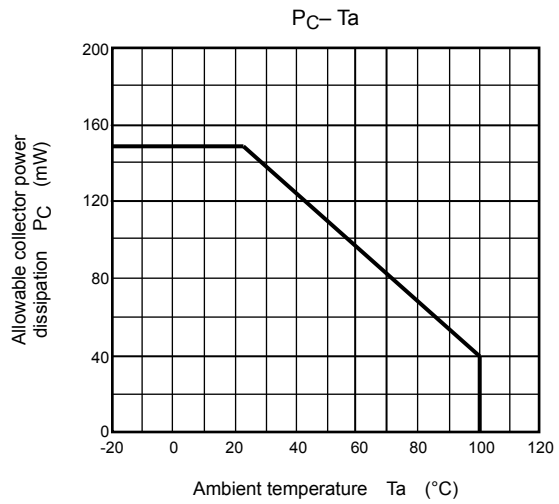
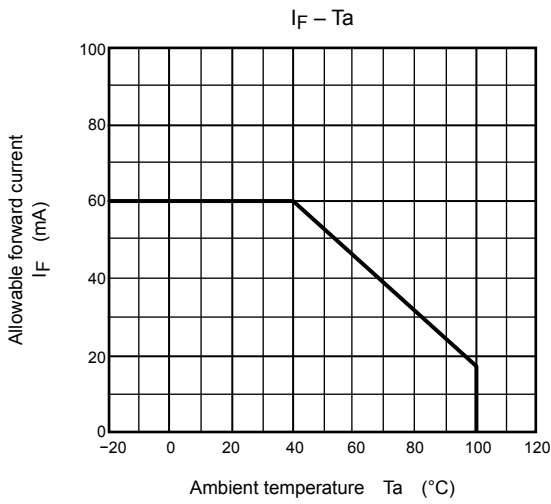

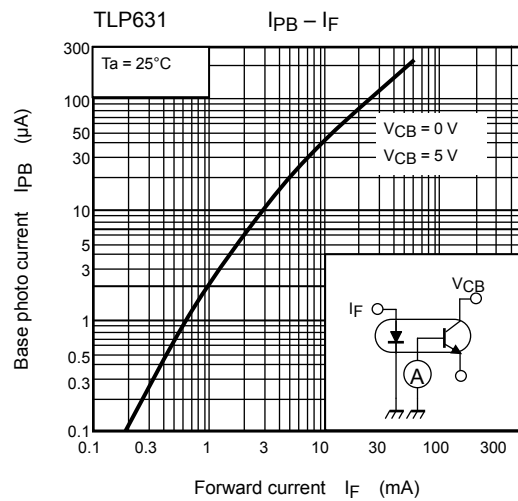
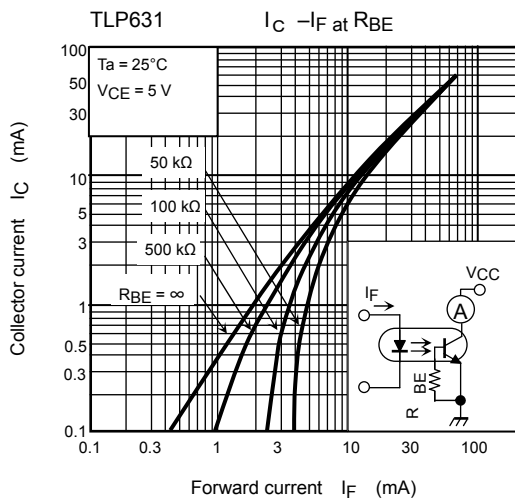
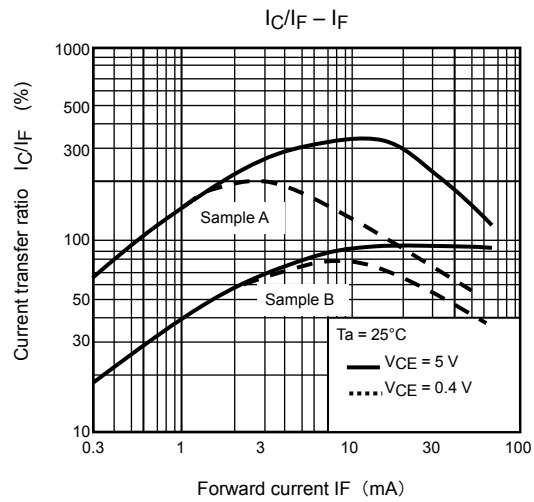
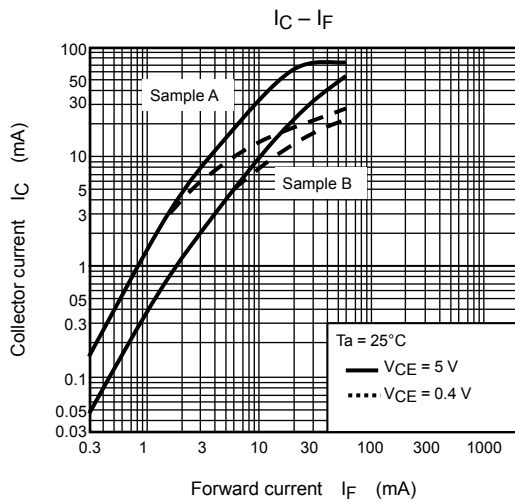
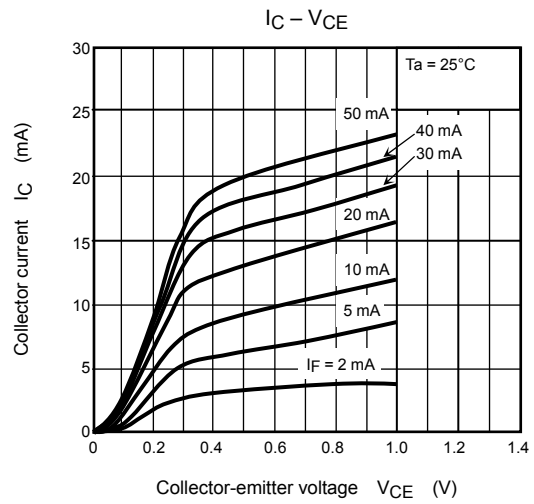
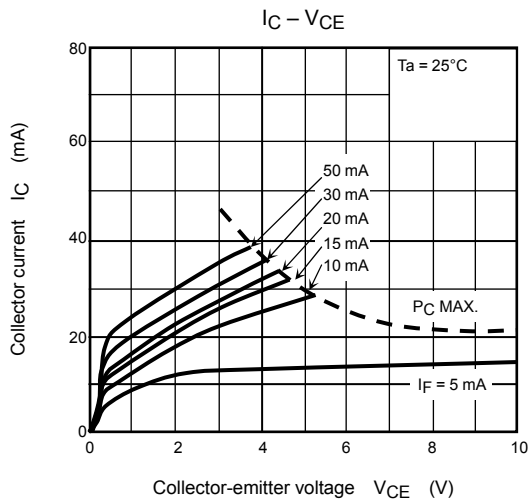

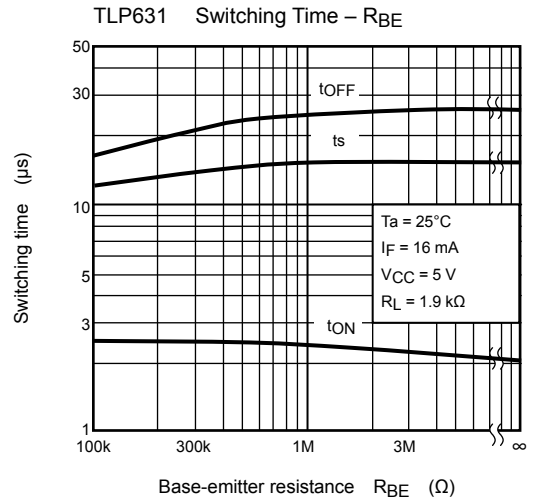
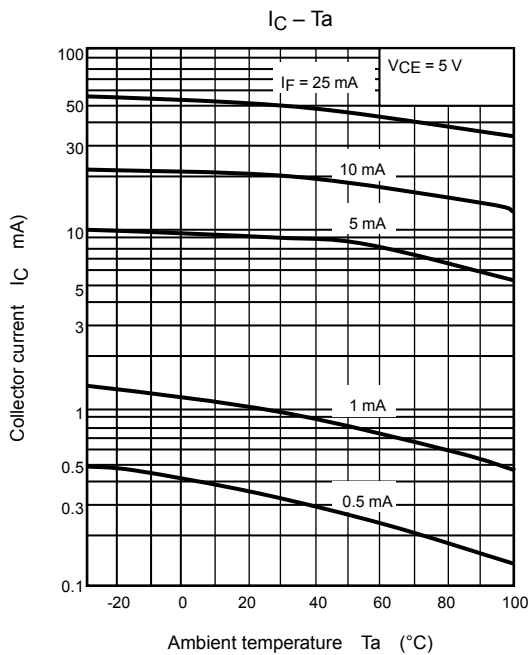
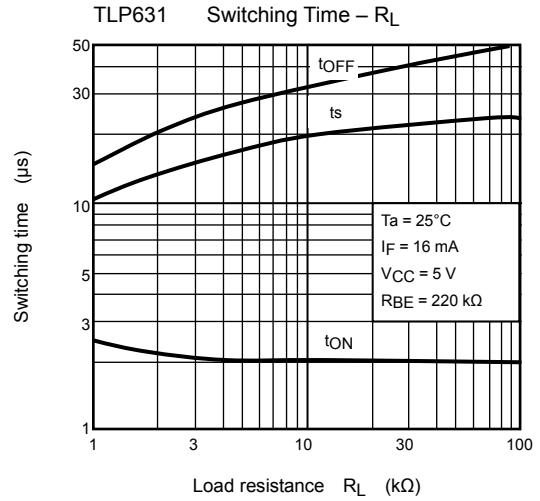
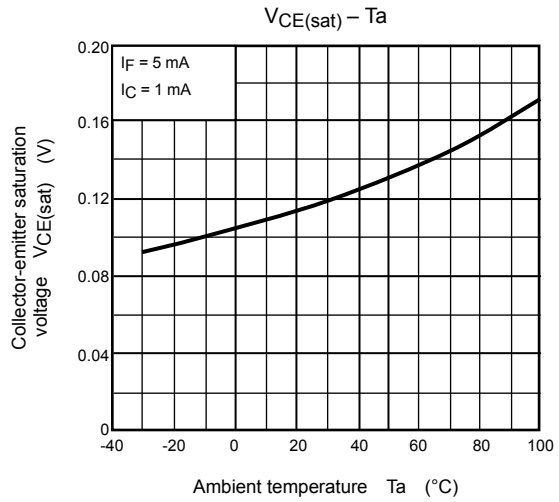
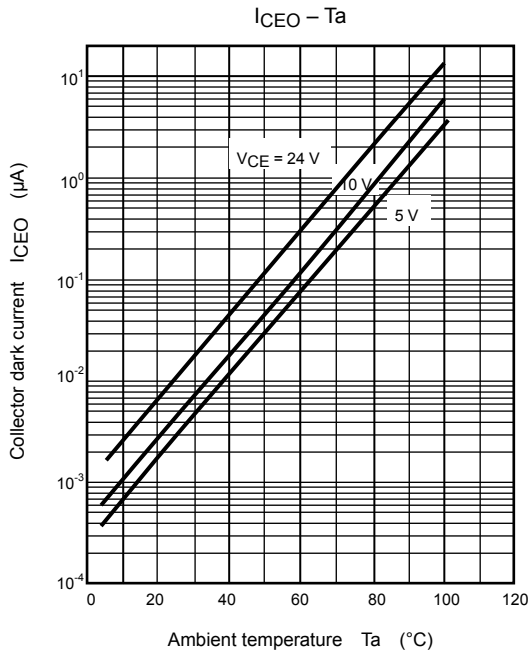

RESTRICTIONS ON PRODUCT USE

20070701-EN

- The information contained herein is subject to change without notice.
- TOSHIBA is continually working to improve the quality and reliability of its products. Nevertheless, semiconductor devices in general can malfunction or fail due to their inherent electrical sensitivity and vulnerability to physical stress. It is the responsibility of the buyer, when utilizing TOSHIBA products, to comply with the standards of safety in making a safe design for the entire system, and to avoid situations in which a malfunction or failure of such TOSHIBA products could cause loss of human life, bodily injury or damage to property.
In developing your designs, please ensure that TOSHIBA products are used within specified operating ranges as set forth in the most recent TOSHIBA products specifications. Also, please keep in mind the precautions and conditions set forth in the "Handling Guide for Semiconductor Devices," or "TOSHIBA Semiconductor Reliability Handbook" etc.
- The TOSHIBA products listed in this document are intended for usage in general electronics applications (computer, personal equipment, office equipment, measuring equipment, industrial robotics, domestic appliances, etc.). These TOSHIBA products are neither intended nor warranted for usage in equipment that requires extraordinarily high quality and/or reliability or a malfunction or failure of which may cause loss of human life or bodily injury ("Unintended Usage"). Unintended Usage include atomic energy control instruments, airplane or spaceship instruments, transportation instruments, traffic signal instruments, combustion control instruments, medical instruments, all types of safety devices, etc.. Unintended Usage of TOSHIBA products listed in this document shall be made at the customer's own risk.
- The products described in this document shall not be used or embedded to any downstream products of which manufacture, use and/or sale are prohibited under any applicable laws and regulations.
- The information contained herein is presented only as a guide for the applications of our products. No responsibility is assumed by TOSHIBA for any infringements of patents or other rights of the third parties which may result from its use. No license is granted by implication or otherwise under any patents or other rights of TOSHIBA or the third parties.
- GaAs(Gallium Arsenide) is used in this product. The dust or vapor is harmful to the human body. Do not break, cut, crush or dissolve chemically.
- Please contact your sales representative for product-by-product details in this document regarding RoHS compatibility. Please use these products in this document in compliance with all applicable laws and regulations that regulate the inclusion or use of controlled substances. Toshiba assumes no liability for damage or losses occurring as a result of noncompliance with applicable laws and regulations.